

SAMSON



HARDWARE MANUFACTURING CATALOGUE

SAMSON INTRODUCTION

For Boltfix, 2019 marks a celebration of 30 years of business in South Africa. We are proud to continue to supply the construction, refrigeration, security, electrical and hardware industries throughout Southern Africa.

We accredit our success to our highly trained and dynamic workforce, who remain committed to providing service excellence to our valued client base. Our trusted quality and ability to provide solutions have allowed Boltfix and the SAMSON brand to become the names you can trust.

Our customers are the lifeblood of the company and our focus remains on forming long-term strategic partnerships, that are both ethical and progressive. We provide tangible and quantifiable benefits to all our clients, and we relentlessly strive to improve not only our service, but also the range and quality of our products.

Our sourcing capability, both locally and internationally, allows us to supply complete solutions to a wide range of industry sectors. Our relationships with our suppliers have, and always will be, built on a foundation of trust and integrity.

OUR MISSION STATEMENT

To be the first choice supply solution.

OUR VISION STATEMENT

To engineer and provide high quality products and supply solutions that meet and exceed all our customers' expectations.



SAMSON CONTENTS

ALUMINIUM

WINDOW & DOOR HARDWARE

05 - 25

STEEL

WINDOW & DOOR HARDWARE

27 - 34

SECURITY

DOOR HARDWARE

35 - 37

WOODEN

WINDOW & DOOR HARDWARE

39 - 49

GARAGE

LOCKS & HARDWARE

51 - 53

FASTENERS

FOR WINDOW & DOOR HARDWARE

54

ALUMINIUM

WINDOW & DOOR HARDWARE

WINDOW HANDLES	6
FRICTION STAYS	6
HINGES	7
PULL HANDLES	8
DOOR HANDLES	9
FLUSH PULL HANDLES	11
NIGHT LATCH	11
LOCKS	12
FOLDING CATCH	16
CYLINDERS	16
FLUSH BOLTS	17
SLIDING FOLDING DOOR HARDWARE	18
PATIO DOOR KITS	20
PATIO DOOR ROLLERS	21
GASKETS	22
CLEATS	24
WOOLPILE	24
PIVOT SETS	25
SILICONE	25
TOUCH UP SPRAYS	25

SAMSON



NYLON ECONO WINDOW HANDLE

STOCK CODE	DESCRIPTION	FINISH
HARD-40020BU	LEFT HAND	BLACK
HARD-40021BU	RIGHT HAND	BLACK

ALUMINIUM EUROLINE WINDOW HANDLE

STOCK CODE	DESCRIPTION	FINISH
HARD-40003BU	LEFT HAND	BLACK
HARD-40004BU	RIGHT HAND	BLACK



Z-4210SS



A2 COUNTERSUNK POZI SELF TAPPER

STOCK CODE	DESCRIPTION	SIZE	FINISH
Z-4210SS	BLUNT POINT	4.2X10MM	STAINLESS STEEL



ALUMINIUM ALCOVE WINDOW HANDLE

STOCK CODE	DESCRIPTION	FINISH
HARD-40024BU	LEFT HAND	BLACK
HARD-40025BU	RIGHT HAND	BLACK



HARD-30011BU



FRICTION STAY

STOCK CODE	TYPE	SIZE	FINISH
HARD-30011BU	304 GRADE	300MM	STAINLESS STEEL
HARD-30012BU	430 GRADE	300MM	STAINLESS STEEL



HIN-20012BU

FINISHES

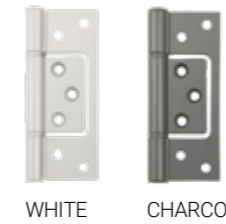

ALUMINIUM FLUSH HINGE 100MM

STOCK CODE	SIZE	FINISH
HIN-20011BU	100X41MM	NATURAL
HIN-20012BU	100X41MM	BRONZE
HIN-20013BU	100X41MM	BLACK
HIN-20006BU	100X44MM	BLACK
HIN-20007BU	100X44MM	BRONZE
HIN-20008BU	100X44MM	NATURAL
HIN-20009BU	100X44MM	WHITE
HIN-20010BU	100X44MM	CHARCOAL



FINISHES



ALUMINIUM FLUSH HINGE 200MM

STOCK CODE	SIZE	FINISH
HIN-20014BU	200X44MM	BLACK
HIN-20015BU	200X44MM	BRONZE
HIN-20016BU	200X44MM	CHARCOAL
HIN-20017BU	200X44MM	NATURAL
HIN-20018BU	200X44MM	WHITE



HIN-10033BU



ALUMINIUM BUTT HINGE

STOCK CODE	SIZE	FINISH
HIN-10033BU	100X75MM	NATURAL



HANP-00001BU

SS STAINLESS STEEL

SCREWS INCLUDED



HANP-00011BU

SS STAINLESS STEEL

SCREWS INCLUDED

STAINLESS STEEL PULL HANDLE

STOCK CODE	SIZE	FINISH
HANP-00001BU	19/130/150MM	STAINLESS STEEL

STAINLESS STEEL PULL HANDLE

STOCK CODE	DESCRIPTION	SIZE	FINISH
HANP-00011BU	CRANKED D	32/300/332MM	STAINLESS STEEL



HANP-00002BU

SS STAINLESS STEEL

SCREWS INCLUDED



HANP-00003BU

SS STAINLESS STEEL

SCREWS INCLUDED

STAINLESS STEEL PULL HANDLE

STOCK CODE	DESCRIPTION	SIZE	FINISH
HANP-00002BU	MITRE T	32/150/400MM	STAINLESS STEEL

STAINLESS STEEL PULL HANDLE

STOCK CODE	DESCRIPTION	SIZE	FINISH
HANP-00003BU	STRAIGHT	32/150/400MM	STAINLESS STEEL

HANP-00005BU



SS STAINLESS STEEL

SCREWS INCLUDED



HANP-00009BU

SS STAINLESS STEEL

SCREWS INCLUDED

HANP-00010BU



STAINLESS STEEL PULL HANDLES

STOCK CODE	DESCRIPTION	SIZE	FINISH
HANP-00005BU	S SHAPE SHORT	32/150/400MM	STAINLESS STEEL
HANP-00008BU	S SHAPE LARGE	32/400/600MM	STAINLESS STEEL

TWO TONE STAINLESS STEEL PULL HANDLES

STOCK CODE	DESCRIPTION	SIZE	FINISH
HANP-00009BU	S SHAPE	32/300/450MM	TWO TONE STAINLESS STEEL
HANP-00010BU	STRAIGHT	32/300/450MM	TWO TONE STAINLESS STEEL



HANC-08022BU

COMPONENTS INCLUDED

FINISHES
 BLACK SILVER
 BRONZE CHARCOAL

LEVER HANDLE MESSINA

STOCK CODE	FINISH
HANC-08019BU	BLACK
HANC-08020BU	BRONZE
HANC-08021BU	SILVER
HANC-08022BU	WHITE
HANC-08029BU	CHARCOAL



HANC-08023BU

COMPONENTS INCLUDED

SS STAINLESS STEEL

LEVER HANDLE RICCI

STOCK CODE	FINISH
HANC-08023BU	STAINLESS STEEL

FINISHES



SCREWS INCLUDED

FINISHES



BLACK

DHALBABZE

SHOPFRONT HANDLE

STOCK CODE	FINISH
HANP-00017BU	BRONZE
HANP-00018BU	NATURAL

UNIVERSAL DOOR HANDLE - CYLINDER HOLE

STOCK CODE	DESCRIPTION	FINISH
DHALBABE	EURO REGAL	BLACK
DHALBABZE	EURO REGAL	BRONZE

FINISHES



BLACK

DHALBABZEB

FINISHES



BLACK

DHALBABZES

UNIVERSAL DOOR HANDLE - BLANK

STOCK CODE	DESCRIPTION	FINISH
DHALBABEB	BLANK - REGAL	BLACK
DHALBABZEB	BLANK - REGAL	BRONZE

UNIVERSAL DOOR HANDLE - SHORT BLANK

STOCK CODE	DESCRIPTION	FINISH
DHALBABES	SHORT - REGAL	BLACK
DHALBABZES	SHORT - REGAL	BRONZE

FLUSH PULL HANDLES

STOCK CODE	SIZE	FINISH
HANP-00014BU	130MM	BLACK
HANP-00015BU	130MM	NATURAL
HANP-00016BU	130MM	BRONZE

FINISHES



NATURAL

BLACK

HANP-00016BU

FINISHES

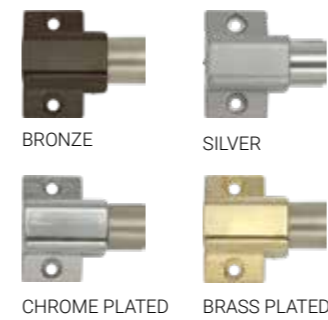

BRONZE

SILVER

CHROME PLATED

BRASS PLATED



LOCK-00043BU

KEYS INCLUDED

COMPONENTS INCLUDED

PATIO DOOR NIGHT LATCH



STOCK CODE	FINISH
LOCK-00040BU	SILVER
LOCK-00041BU	BRASS PLATED
LOCK-00042BU	CHROME PLATED
LOCK-00043BU	BLACK
LOCK-00044BU	BRONZE



 **SS201 GRADE**
 **SCREWS INCLUDED**
 **KEYS INCLUDED**



ECONO LATCH LOCK		
STOCK CODE	DESCRIPTION	SIZE
LOCK-00051BU	25 BACKSET ECONO	25MM
LOCK-50001BX	25 BACKSET ECONO + 60MM CHROME PLATED CYLINDER	25MM
LOCK-50002BX	25 BACKSET ECONO + 65MM SATIN NICKEL CYLINDER	25MM
LOCK-00052BU	35 BACKSET ECONO	35MM
LOCK-50003BX	35 BACKSET ECONO + 60MM CHROME PLATED CYLINDER	35MM
LOCK-50004BX	35 BACKSET ECONO + 65MM SATIN NICKEL CYLINDER	35MM



 **SCREWS INCLUDED**
 **KEYS INCLUDED**
 **SS304 GRADE**

PREMIUM LATCH LOCK		
STOCK CODE	DESCRIPTION	SIZE
LOCK-00004BU	35 BACKSET	35MM
LOCK-50005BX	35 BACKSET + 60MM CHROME PLATED CYLINDER	35MM
LOCK-50006BX	35 BACKSET + 65MM SATIN NICKEL CYLINDER	35MM



 **SCREWS INCLUDED**
 **KEYS INCLUDED**
 **SS304 GRADE**

PREMIUM DEAD LOCK		
STOCK CODE	DESCRIPTION	SIZE
LOCK-00007BU	25 BACKSET	25MM
LOCK-50013BX	25 BACKSET + 60MM CHROME PLATED CYLINDER	25MM
LOCK-50014BX	25 BACKSET + 65MM SATIN NICKEL CYLINDER	25MM
LOCK-00008BU	35 BACKSET	35MM
LOCK-50015BX	35 BACKSET + 60MM CHROME PLATED CYLINDER	35MM
LOCK-50016BX	35 BACKSET + 65MM SATIN NICKEL CYLINDER	35MM



LOCK-00053BU

LOCK-50007BX

LOCK-50008BX

SCREWS INCLUDED

KEYS INCLUDED

SS201 GRADE

ECONO ROLLER LOCK 25MM		
STOCK CODE	DESCRIPTION	SIZE
LOCK-00053BU	25 BACKSET ECONO	25MM
LOCK-50007BX	25 BACKSET ECONO + 60MM CHROME PLATED CYLINDER	25MM
LOCK-50008BX	25 BACKSET ECONO + 65MM SATIN NICKEL CYLINDER	25MM



LOCK-00054BU

LOCK-50011BX

KEYS INCLUDED

SCREWS INCLUDED

SS304 GRADE

HOOK LOCK WITH LATCH STAINLESS STEEL		
STOCK CODE	DESCRIPTION	SIZE
LOCK-00054BU	35MM HOOK LOCK WITH LATCH (7MM THROW)	35MM
LOCK-50011BX	35MM HOOK LOCK (7MM THROW) + 65MM SATIN NICKEL CYLINDER	35MM

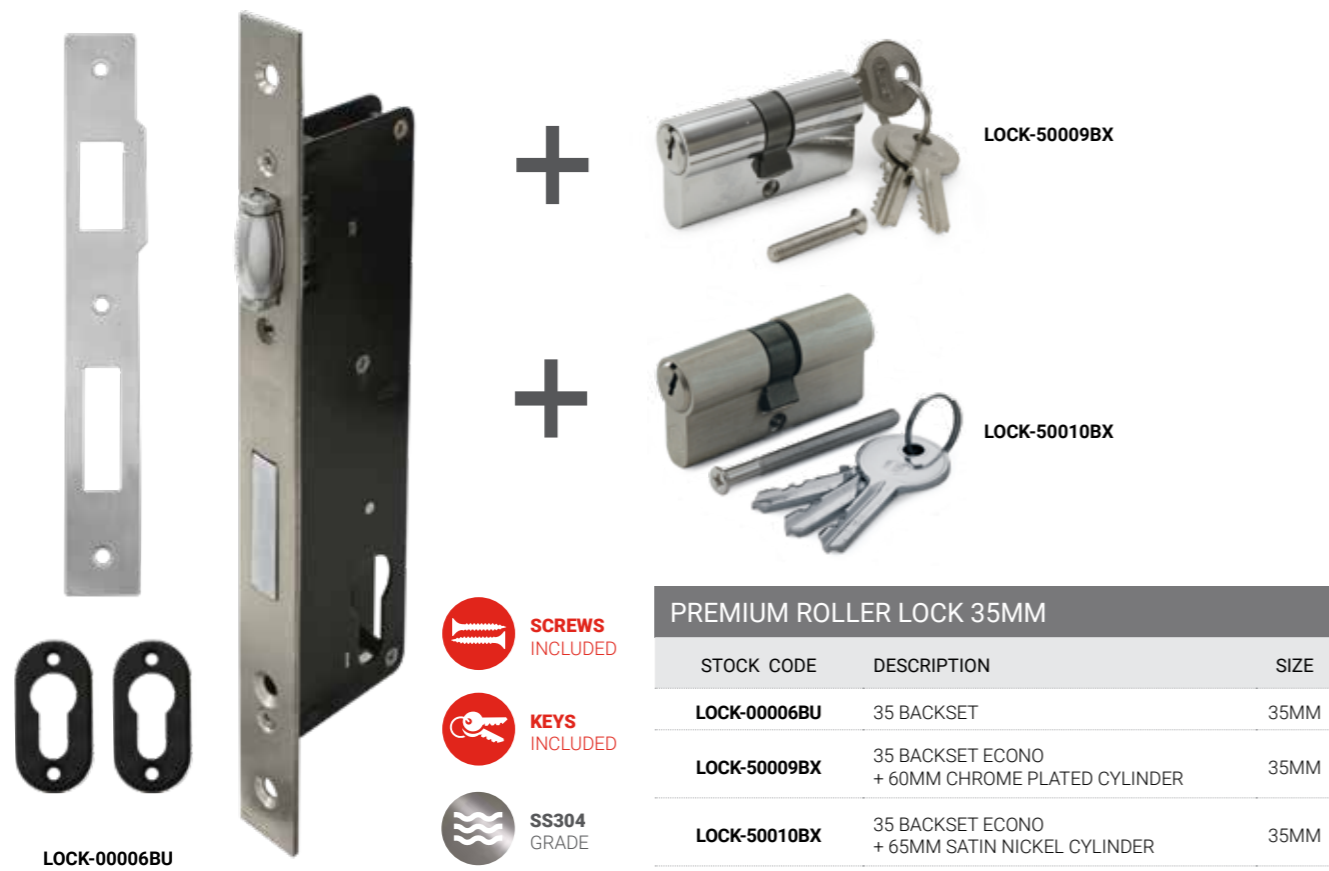

LOCK-00006BU

LOCK-50009BX

LOCK-50010BX

SCREWS INCLUDED

KEYS INCLUDED

SS304 GRADE

PREMIUM ROLLER LOCK 35MM		
STOCK CODE	DESCRIPTION	SIZE
LOCK-00006BU	35 BACKSET	35MM
LOCK-50009BX	35 BACKSET ECONO + 60MM CHROME PLATED CYLINDER	35MM
LOCK-50010BX	35 BACKSET ECONO + 65MM SATIN NICKEL CYLINDER	35MM



LOCK-00055BU

LOCK-50012BX

KEYS INCLUDED

SCREWS INCLUDED

SS304 GRADE

HOOK LOCK WITH NO LATCH STAINLESS STEEL		
STOCK CODE	DESCRIPTION	SIZE
LOCK-00055BU	35MM HOOK LOCK WITH NO LATCH (7MM THROW)	35MM
LOCK-50012BX	35MM HOOK LOCK (7MM THROW) + 65MM SATIN NICKEL CYLINDER	35MM



HARD-0029BU



FOLDING CATCH BLACK

STOCK CODE	FINISH
HARD-0029BU	BLACK



CYL-00011BU



PATIO DOOR FORTRESS CYLINDER

STOCK CODE	FINISH
CYL-00011BU	BRASS PLATED



CYL-00005BU

FINISHES

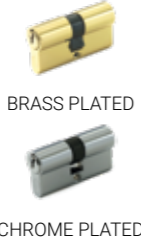

EURO CYLINDER

STOCK CODE	TYPE	SIZE	FINISH
CYL-00005BU	KEY TO DIFFER	65MM	SATIN NICKEL
CYL-00006BU	KEY TO DIFFER	65MM	BRASS PLATED
CYL-00007BU	KEY TO DIFFER	65MM	CHROME PLATED
CYL-00008BU	KEYED ALIKE	65MM	SATIN NICKEL

CYL-00013BU



EURO HALF CYLINDER

STOCK CODE	FINISH
CYL-00013BU	SATIN NICKEL



CYL-00002BU



ECONO EURO CYLINDER

STOCK CODE	SIZE	FINISH
CYL-00002BU	60MM	CHROME PLATED



CYL-00012BU



EURO KNOB CYLINDER

STOCK CODE	SIZE	FINISH
CYL-00012BU	65MM	SATIN NICKEL



FINISHES



SINGLE ACTION FLUSH BOLT (SPARTAN)

STOCK CODE	DESCRIPTION	FINISH
BOLT-00003BU	SINGLE ACTION + STD ACCESSORIES	BLACK
BOLT-00004BU	SINGLE ACTION + STD ACCESSORIES	BRONZE
BOLT-00005BU	SINGLE ACTION + STD ACCESSORIES	NATURAL
BOLT-00006BU	SINGLE ACTION + STD ACCESSORIES	WHITE



FINISHES



DOUBLE ACTION FLUSH BOLT

STOCK CODE	DESCRIPTION	FINISH
BOLT-00007BU	DOUBLE ACTION + STD BRACKETS	BLACK
BOLT-00008BU	DOUBLE ACTION + STD BRACKETS	BRONZE



FINISHES



BRONZE NATURAL WHITE

FINISHES



BRONZE NATURAL WHITE

BUTT HINGE WITH BOTTOM ROLLER

STOCK CODE	DESCRIPTION	SIZE	FINISH
SD-RBBE	STAINLESS STEEL ROLLER	100MM	BLACK
SD-RBNA	STAINLESS STEEL ROLLER	100MM	NATURAL
SD-RBWE	STAINLESS STEEL ROLLER	100MM	WHITE
SD-RBZE	STAINLESS STEEL ROLLER	100MM	BRONZE

INTERMEDIATE BUTT HINGE WITH NYLON HANDLE

STOCK CODE	DESCRIPTION	SIZE	FINISH
SD-HHBBE	NYLON HANDLE	100MM HINGE	BLACK
SD-HHBBZE	NYLON HANDLE	100MM HINGE	BRONZE
SD-HHBNA	NYLON HANDLE	100MM HINGE	NATURAL
SD-HHBWE	NYLON HANDLE	100MM HINGE	WHITE



FINISHES



BRONZE NATURAL WHITE

FINISHES



BRONZE NATURAL WHITE

INTERMEDIATE MIDDLE BUTT HINGE

STOCK CODE	DESCRIPTION	SIZE	FINISH
SD-HBBE	BUTT HINGE	100MM	BLACK
SD-HBBZE	BUTT HINGE	100MM	BRONZE
SD-HBNA	BUTT HINGE	100MM	NATURAL
SD-HBWE	BUTT HINGE	100MM	WHITE

OFFSET BUTT HINGE GUIDE

STOCK CODE	DESCRIPTION	SIZE	FINISH
SD-GBBER	STAINLESS STEEL ROLLER	100MM HINGE	BLACK
SD-GBBZER	STAINLESS STEEL ROLLER	100MM HINGE	BRONZE
SD-GBNAR	STAINLESS STEEL ROLLER	100MM HINGE	NATURAL
SD-GBWER	STAINLESS STEEL ROLLER	100MM HINGE	WHITE



FINISHES



BRONZE NATURAL WHITE

FINISHES



BRONZE NATURAL WHITE

FLUSH HINGE WITH BOTTOM ROLLER

STOCK CODE	DESCRIPTION	SIZE	FINISH
SD-RFBE	STAINLESS STEEL ROLLER	100MM	BLACK
SD-RFBZE	STAINLESS STEEL ROLLER	100MM	BRONZE
SD-RFNA	STAINLESS STEEL ROLLER	100MM	NATURAL
SD-RFWE	STAINLESS STEEL ROLLER	100MM	WHITE

INTERMEDIATE MIDDLE FLUSH HINGE WITH NYLON HANDLE

STOCK CODE	DESCRIPTION	SIZE	FINISH
SD-HHFBE	NYLON HANDLE	100MM FLUSH HINGE	BLACK
SD-HHFBZE	NYLON HANDLE	100MM FLUSH HINGE	BRONZE
SD-HHFNA	NYLON HANDLE	100MM FLUSH HINGE	NATURAL
SD-HHFWE	NYLON HANDLE	100MM FLUSH HINGE	WHITE



FINISHES



BRONZE NATURAL WHITE

FINISHES



BRONZE NATURAL WHITE

INTERMEDIATE MIDDLE FLUSH HINGE

STOCK CODE	DESCRIPTION	SIZE	FINISH
SD-HFBE	FLUSH HINGE	100MM	BLACK
SD-HFBZE	FLUSH HINGE	100MM	BRONZE
SD-HFNA	FLUSH HINGE	100MM	NATURAL
SD-HFWE	FLUSH HINGE	100MM	WHITE

OFFSET FLUSH HINGE GUIDE

STOCK CODE	DESCRIPTION	SIZE	FINISH
SD-GFBER	STAINLESS STEEL ROLLER	100MM FLUSH HINGE	BLACK
SD-GFBZER	STAINLESS STEEL ROLLER	100MM FLUSH HINGE	BRONZE
SD-GFNAR	STAINLESS STEEL ROLLER	100MM FLUSH HINGE	NATURAL
SD-GFWER	STAINLESS STEEL ROLLER	100MM FLUSH HINGE	WHITE

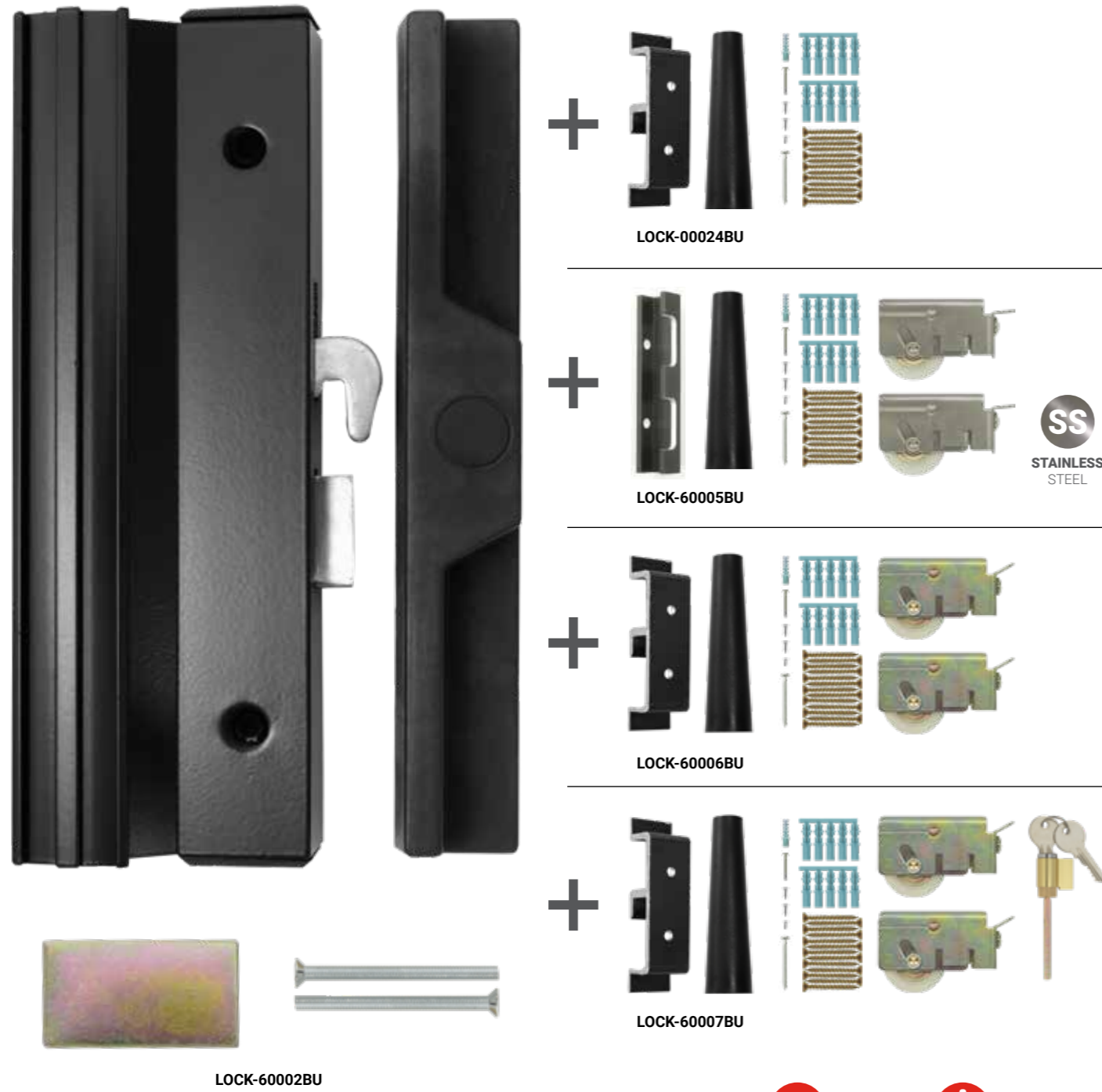

SCREWS INCLUDED **COMPONENTS INCLUDED**

PATIO DOOR	
STOCK CODE	DESCRIPTION
LOCK-60002BU	PATIO DOOR HANDLE ONLY
LOCK-00024BU	PATIO DOOR KIT + E KEEP + DOOR STOPPER
LOCK-60005BU	PATIO DOOR KIT + CLOSED KEEP + DOOR STOPPER + 2X STAINLESS STEEL 15MM ROLLERS
LOCK-60006BU	PATIO DOOR KIT + E KEEP + DOOR STOPPER + 2X YELLOW ZINC PLATED 15MM ROLLERS
LOCK-60007BU	PATIO DOOR KIT + E KEEP + DOOR STOPPER + 2X YELLOW ZINC PLATED 15MM ROLLERS + FORTRESS CYLINDER

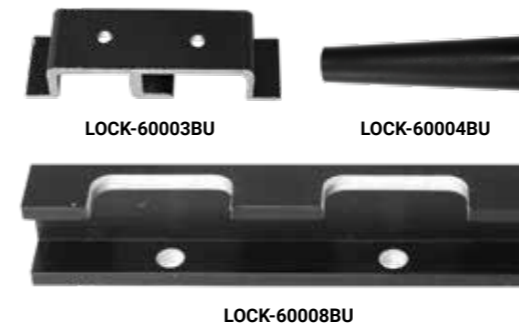

PATIO DOOR ACCESSORIES	
STOCK CODE	DESCRIPTION
LOCK-60003BU	PATIO DOOR E KEEP
LOCK-60008BU	PATIO DOOR CLOSED KEEP
LOCK-60004BU	DOORSTOP 95 RUBBER



PATIO DOOR HANDLE MINI	
STOCK CODE	DESCRIPTION
LOCK-60001BU	PATIO DOOR HANDLE MINI INNER WITH KEEP

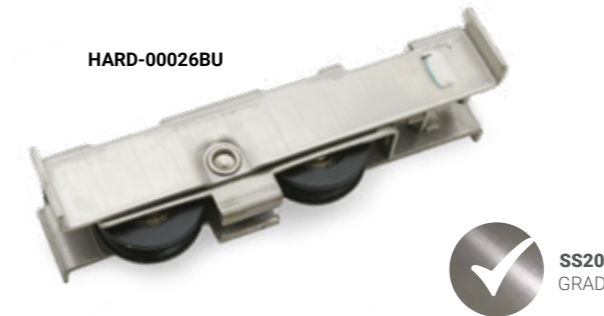

DOUBLE DOOR BOGEY ROLLER NYLON WHEEL		
STOCK CODE	DESCRIPTION	FINISH
HARD-00026BU	BOGEY ROLLER NYLON WHEEL	STAINLESS STEEL

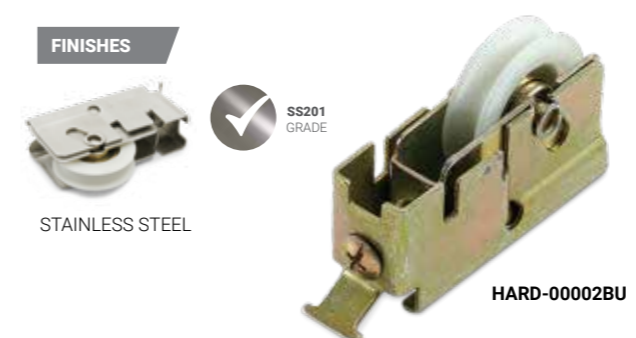

PATIO DOOR ROLLER		
STOCK CODE	SIZE	FINISH
HARD-00001BU	15MM	STAINLESS STEEL
HARD-00002BU	15MM	YELLOW PLATED

DOUBLE DOOR ROLLER	
STOCK CODE	FINISH
HARD-00003BU	STAINLESS STEEL
HARD-00004BU	YELLOW PLATED

DOUBLE SEAL AND 'Y' GASKETS (100 METER ROLL)

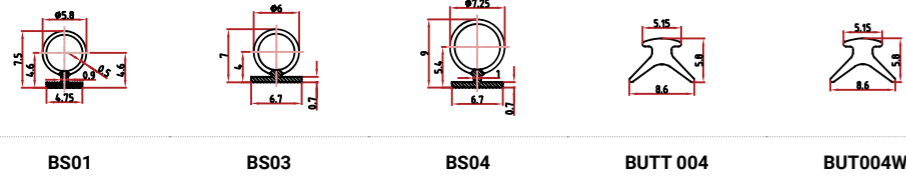

BEAD/BUTTERFLY GASKETS (100 METER ROLL)

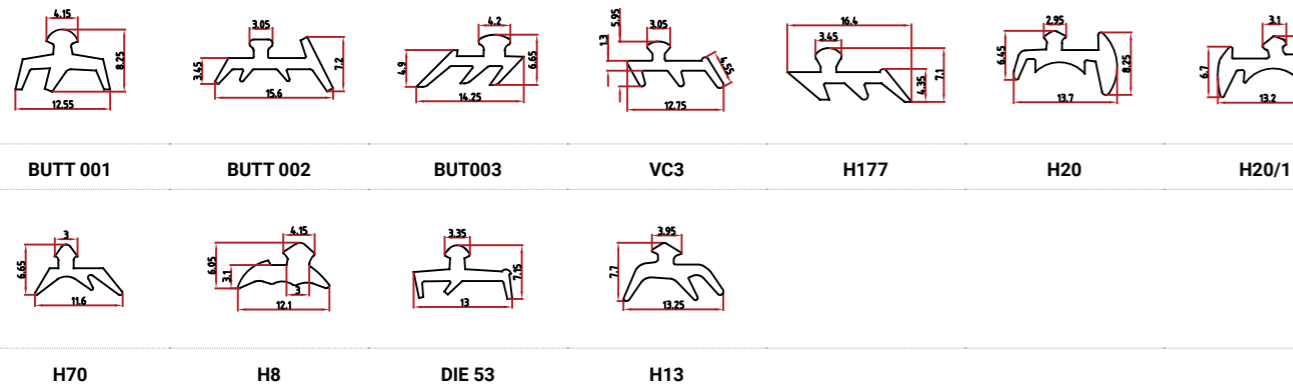

BACK WEDGE 2 FIN SERIES (100 METER ROLL)

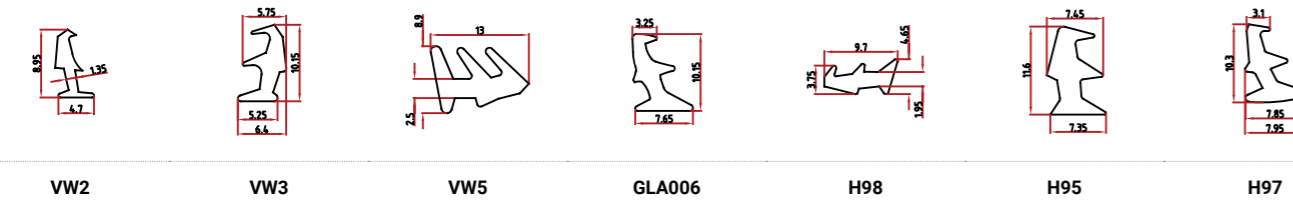

BACK WEDGE CORRUGATED SERIES (100 METER ROLL)

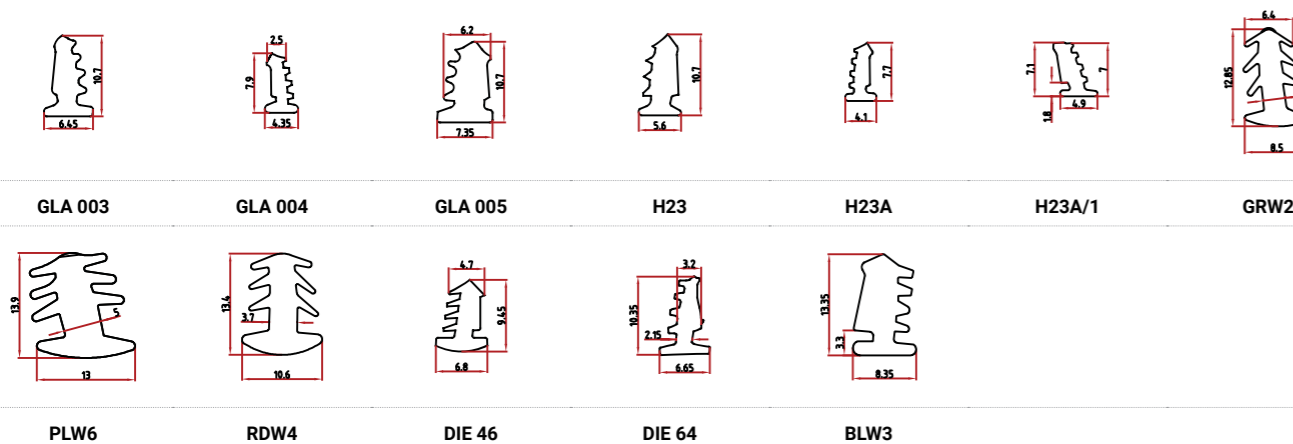

GLAZING BACK WEDGE SOLID SERIES (50 AND 100 METER ROLL)

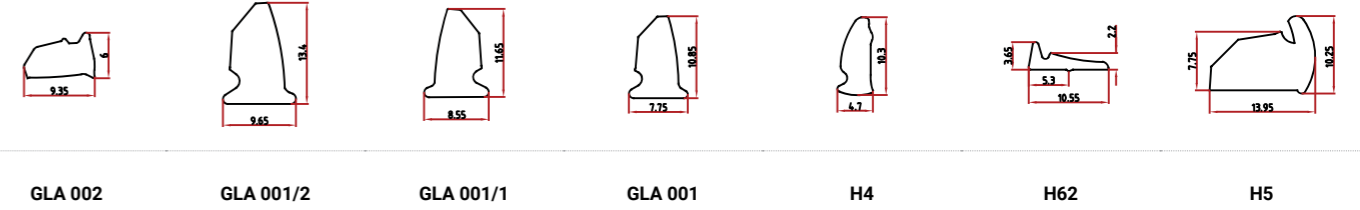

CHANNEL GASKETS (100 METER ROLL)

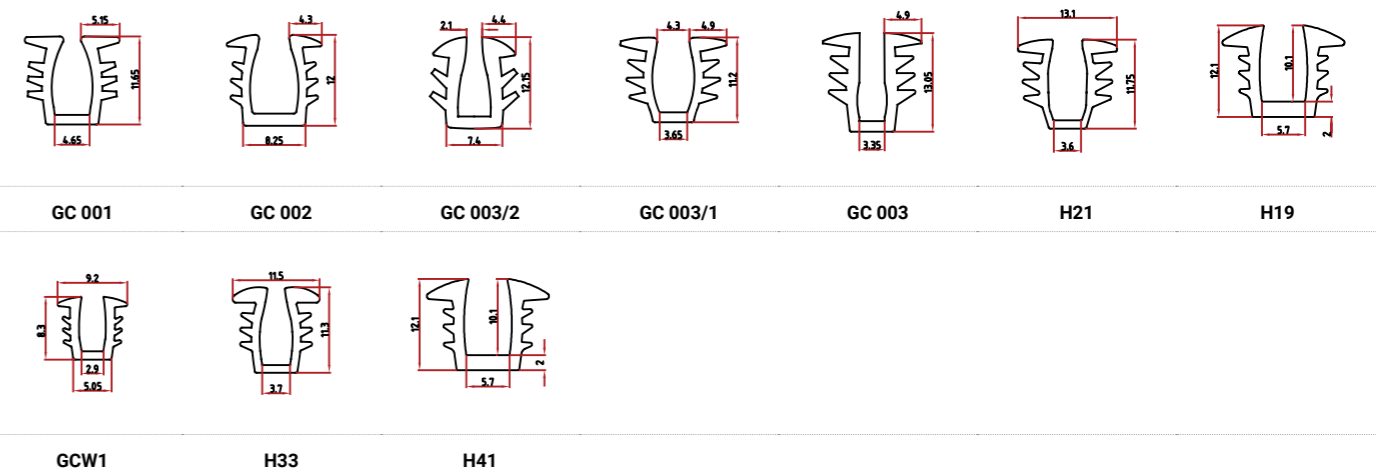

SAMSON

For more information on our roll specifications, please contact our Sales Team.

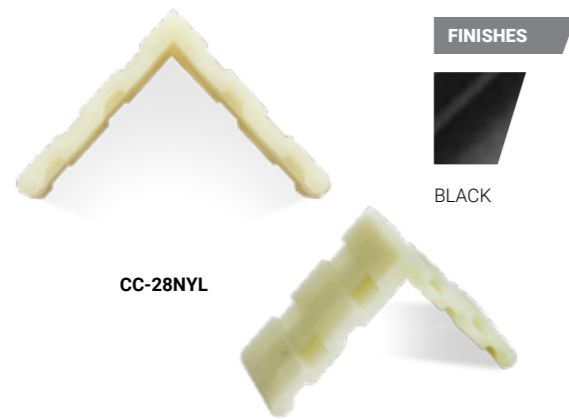

FINISHES
BLACK

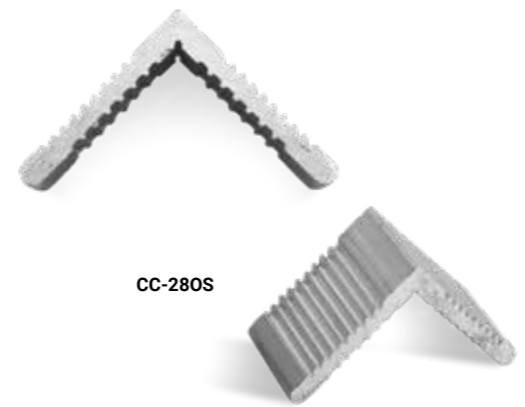

NYLON CORNER CUT CLEAT		
STOCK CODE	SIZE	FINISH
CC-28NYL	28MM	NYLON TRADITIONAL WHITE
CC-30.5NYL	30.5MM	NYLON TRADITIONAL WHITE
CC-PL7001	28MM	NYLON TRADITIONAL BLACK

ALUMINIUM OSBORN CORNER CUT CLEAT		
STOCK CODE	SIZE	FINISH
CC-28OS	28MM	NATURAL ALUMINIUM
CC-30.5OS	30.5MM	NATURAL ALUMINIUM

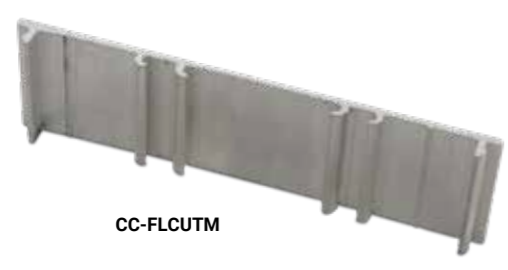

ALUMINIUM CUT FIXING LUG MULTI	
STOCK CODE	FINISH
CC-FLCUTM	NATURAL ALUMINIUM

ALUMINIUM SHOPFRONT SPIGOT CUT		
STOCK CODE	SIZE	FINISH
CC-26SCUT	26MM	NATURAL ALUMINIUM



WOOLPILE	
STOCK CODE	DESCRIPTION
WP48/500	WOOLPILE 4.8MM BASE 5MM WOOL
WP67/500	WOOLPILE 6.7MM BASE 5MM WOOL
WP67/600	WOOLPILE 6.7MM BASE 6MM WOOL
WP67/750	WOOLPILE 6.7MM BASE 7.5MM WOOL
WP67/900	WOOLPILE 6.7MM BASE 9MM WOOL



R4 SPIGOT CUT ALUMINIUM	
STOCK CODE	DESCRIPTION
CC-R4SCUT	R4 SPIGOT CUT ALUMINIUM

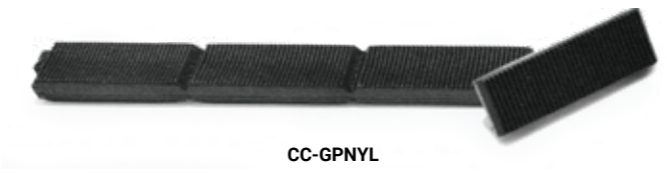

GLASS PACKER	
STOCK CODE	DESCRIPTION
CC-GPNYL	GLASS PACKER



SILICONE			
STOCK CODE	DESCRIPTION	SIZE	FINISH
S-SILNOBE	NEUTRAL	280ML	BLACK
S-SILNOBZE	NEUTRAL	280ML	BRONZE
S-SILNOC	NEUTRAL	280ML	CLEAR
S-SILNOWE	NEUTRAL	280ML	WHITE
S-SILNOCHL	NEUTRAL	280ML	CHARCOAL
S-SILNOGR	NEUTRAL	280ML	GREY
S-SILACWE	ACRYLIC	280ML	WHITE

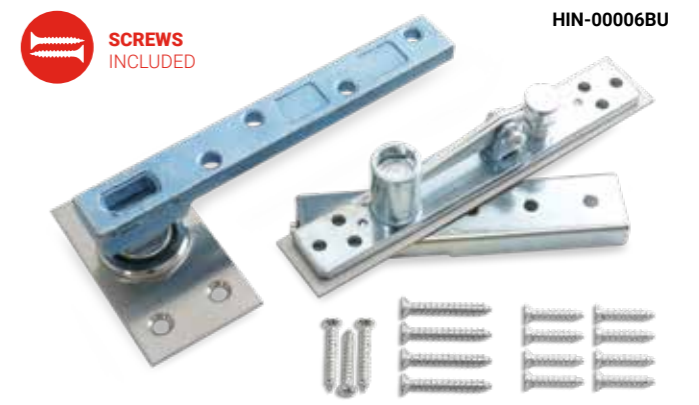

ADJUSTABLE PIVOT SET	
STOCK CODE	DESCRIPTION
HIN-00006BU	ADJUSTABLE PIVOT SET



TIE ROD & ACCESSORIES		
STOCK CODE	DESCRIPTION	FINISH
TR8MMGAL	3 METER TIE RODS (8MM DIAMETER)	ZINC PLATED
TR8MMN	8MM HEX NUTS FOR TIE RODS	ZINC PLATED
TR8MMW	8MM WASHERS FOR TIE RODS	ZINC PLATED



TOUCH UP SPRAY			
STOCK CODE	DESCRIPTION	SIZE	FINISH
S-TUSD BE	ANP39005	400ML	BLACK
S-TUSD BZE	ANP9085	400ML	BRONZE
S-TUSD CH	ANP3055	400ML	CHARCOAL
S-TUSD NAT	N/A	400ML	NATURAL
S-TUSD SE	ANP9089	400ML	NEW SILVER
S-TUSD WE	ANP1052	400ML	WHITE
S-TUMD BZE	QUICK DRY MIX	400ML	DARK BRONZE

STEEL

WINDOW & DOOR HARDWARE

WINDOW HANDLES	28
WINDOW BRACKETS	29
SLIDING STAYS & SLIDING STAY BRACKETS	30
PEG STAYS & PEG STAY BRACKETS	31
SPRING CATCH	32
DOOR HINGES	32

SAMSON



COMPONENTS INCLUDED

ECONO ALUMINIUM WINDOW HANDLE

STOCK CODE	DESCRIPTION	FINISH
HARD-40005BU	LEFT HAND	YELLOW ZINC PLATED
HARD-40006BU	RIGHT HAND	YELLOW ZINC PLATED



COMPONENTS INCLUDED

PRESSED STEEL WINDOW HANDLE

STOCK CODE	DESCRIPTION	FINISH
SWM-HANLG	LEFT HAND	YELLOW ZINC PLATED
SWM-HANRG	RIGHT HAND	YELLOW ZINC PLATED



BRASS WINDOW HANDLE

STOCK CODE	DESCRIPTION
HARD-40001BU	LEFT HAND
HARD-40002BU	RIGHT HAND



ALUMINIUM WINDOW HANDLE

STOCK CODE	DESCRIPTION	FINISH
HARD-40022BU	LEFT HAND	BRASS PLATED
HARD-40023BU	RIGHT HAND	BRASS PLATED

WINDOW HANDLE ACCESSORIES

STOCK CODE	DESCRIPTION
SWM-MUSH-WASH	BOLT AND GROMMET FOR WINDOW HANDLES
SWM-HEX-WASH	M8X13 HEX HEAD SCREW AND GROMMET FOR STEEL PRESSED WINDOW HANDLE



SWM-MUSH-WASH



SWM-HEX-WASH
(FOR STEEL PRESSED WINDOW HANDLE)



FINISHES



ZINC PLATED

MILD STEEL

SWM-HANPLH

HANDLE PLATE - RIVET ON

STOCK CODE	DESCRIPTION	FINISH
SWM-HANPLH	LEFT HAND	SELF COLOUR
SWM-HANPRH	RIGHT HAND	SELF COLOUR
SWM-AV003	LEFT HAND	ZINC PLATED
SWM-AV004	RIGHT HAND	ZINC PLATED



MILD STEEL

SWM-HANPLHNP

HANDLE PLATE - WELD ON

STOCK CODE	DESCRIPTION	FINISH
SWM-HANPLHNP	LEFT HAND	SELF COLOUR
SWM-HANPRHNP	RIGHT HAND	SELF COLOUR

SWM-HINCP

MILD STEEL

COTTAGE PIN

STOCK CODE	FINISH
SWM-HINCP	SELF COLOUR



SWM-HINL11

MILD STEEL

HINGE LIP/BARREL LEG

STOCK CODE	SIZE	FINISH
SWM-HINL05	5MM LIP	SELF COLOUR
SWM-HINL11	11MM LIP	SELF COLOUR

SWM-UPLATE11

MILD STEEL

HINGE U PLATE

STOCK CODE	SIZE	FINISH
SWM-UPLATE11	11MM LIP	SELF COLOUR

SWM-TD

MILD STEEL

TEARDROP WITH STEEL PIN

STOCK CODE	FINISH
SWM-TD	SELF COLOUR

HARD-30009BU

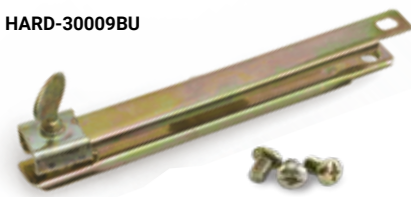

SCREWS INCLUDED

HARD-30031BU



SCREWS INCLUDED

STEEL SLIDING STAY WITH STEEL BOX

STOCK CODE	SIZE	FINISH
HARD-30009BU	150MM	YELLOW ZINC PLATED

STEEL SLIDING STAY WITH CAST BOX

STOCK CODE	SIZE	FINISH
HARD-30031BU	175MM	YELLOW ZINC PLATED

HARD-30006BU



SOLID BRASS

SWM-AV010



SOLID BRASS SLIDING STAY

STOCK CODE	SIZE	FINISH
HARD-30006BU	150MM	SOLID BRASS
HARD-30007BU	175MM	SOLID BRASS
HARD-30008BU	270MM	SOLID BRASS

ALUMINIUM SLIDING STAY

STOCK CODE	SIZE	FINISH
SWM-AV010	150MM	BRASS PLATED

SWM-WSC06065Y



SWM-WSC06095Y

Please Note: You require two top screws and one bottom screw per sliding stay installation.

SLIDING STAY SCREWS

STOCK CODE	DESCRIPTION	SIZE	FINISH
SWM-WSC06065Y	TOP SCREW	M6X6MM	YELLOW ZINC PLATED
SWM-WSC06095Y	BOTTOM SCREW	M6X9.5MM	YELLOW ZINC PLATED

SWM-BRARN

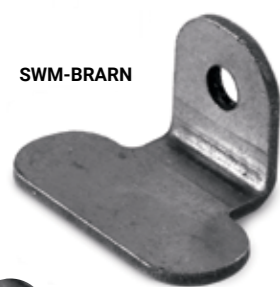

SWM-BRASN



MILD STEEL



MILD STEEL



SWM-BRASN-RW

SLIDING STAY BRACKET - ECONO WELD ON

STOCK CODE	DESCRIPTION	FINISH
SWM-BRASN-RW	SQUARE/ROUND NOSE UNIVERSAL BRACKET	SELF COLOUR

SLIDING STAY BRACKET - STANDARD WELD ON

STOCK CODE	DESCRIPTION	FINISH
SWM-BRARN	STEEL ROUND NOSE BRACKET	SELF COLOUR
SWM-BRASN	STEEL SQUARE NOSE BRACKET	SELF COLOUR



HARD-30003BU



SCREWS INCLUDED



HARD-30027BU



SCREWS INCLUDED

STEEL PEG STAY WITH STEEL KNUCKLE

STOCK CODE	SIZE	FINISH
HARD-30003BU	200MM	YELLOW ZINC PLATED
HARD-30004BU	250MM	YELLOW ZINC PLATED
HARD-30005BU	300MM	YELLOW ZINC PLATED

STEEL PEG STAY WITH CAST KNUCKLE

STOCK CODE	SIZE	FINISH
HARD-30027BU	200MM	YELLOW ZINC PLATED
HARD-30028BU	250MM	YELLOW ZINC PLATED
HARD-30029BU	300MM	YELLOW ZINC PLATED



HARD-30001BU



SOLID BRASS



SWM-WSC06012Y

SOLID BRASS PEG STAY

STOCK CODE	SIZE	FINISH
HARD-30001BU	200MM	SOLID BRASS
HARD-30002BU	250MM	SOLID BRASS

SCREW FOR PEG STAY

STOCK CODE	SIZE	FINISH
SWM-WSC06012Y	M6X12	YELLOW ZINC PLATED



SWM-STARNP



SWM-PP



SWM-BRAR



SWM-STARNP-RW

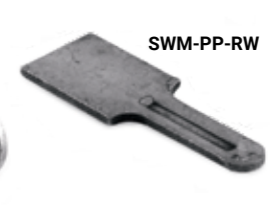

SWM-PP-RW



SWM-BRAR-RW



MILD STEEL



MILD STEEL

STEEL PEGSTAY BRACKETS - STANDARD WELD ON

STOCK CODE	DESCRIPTION	FINISH
SWM-STARNP	STEEL PEGSTAY FIXING BRACKET	SELF COLOUR
SWM-PP	STEEL PEGSTAY PIN BRACKET	SELF COLOUR
SWM-BRAR	STEEL PEGSTAY REST BRACKET	SELF COLOUR

STEEL PEGSTAY BRACKETS - ECONO WELD ON

STOCK CODE	DESCRIPTION	FINISH
SWM-STARNP-RW	STEEL PEGSTAY FIXING BRACKET	SELF COLOUR
SWM-PPRW	STEEL PEGSTAY PIN BRACKET	SELF COLOUR
SWM-BRAR-RW	STEEL PEGSTAY REST BRACKET	SELF COLOUR

SOLID BRASS SPRING CATCH

STOCK CODE	DESCRIPTION	FINISH
HARD-00009BU	SPRING CATCH	SOLID BRASS
SWM-SCPST	STEEL PLATE	SELF COLOUR



HARD-00009BU



MILD STEEL

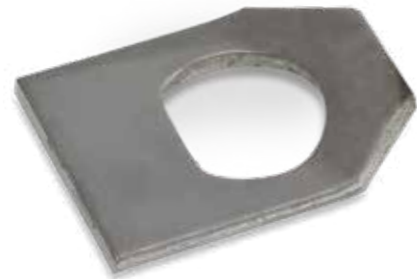

SWM-SCPST



HIN-10013BU

FINISHES



SELF COLOUR



SCREWS INCLUDED



X2 SUPPLIED AS PAIR



HIN-10008BU



X2 SUPPLIED AS PAIR

STEEL BUTT HINGE

STOCK CODE	SIZE	FINISH
HIN-10006BU	75MM	SELF COLOUR
HIN-10007BU	100MM	SELF COLOUR
HIN-10012BU	75MM	ZINC PLATED
HIN-10013BU	100MM	ZINC PLATED

HEAVY DUTY BUTT HINGE

STOCK CODE	SIZE	FINISH
HIN-10008BU	100MMX68MM	SELF COLOUR



HIN-10031BU

FINISHES



SATIN NICKEL



BRASS PLATED



MILD STEEL



SCREWS INCLUDED



X2 SUPPLIED AS PAIR



HIN-10034BU

FINISHES



STAINLESS STEEL PVD



STAINLESS STEEL



SCREWS INCLUDED



X2 SUPPLIED AS PAIR

BALL BEARING BUTT HINGE

STOCK CODE	SIZE	FINISH
HIN-10030BU	100X75X2MM	BRASS PLATED
HIN-10031BU	100X75X2MM	CHROME PLATED
HIN-10032BU	100X75X2MM	SATIN NICKEL



HIN-10002BU



X2 SUPPLIED AS PAIR

STEEL BUTT HINGE WELD ON

STOCK CODE	SIZE	FINISH
HIN-10001BU	75MM	SELF COLOUR
HIN-10002BU	100MM	SELF COLOUR
HIN-10036BU	100MM	ZINC PLATED

BALL BEARING BUTT HINGE

STOCK CODE	SIZE	FINISH
HIN-10034BU	100X75MMX2.2	STAINLESS STEEL
HIN-10035BU	100X75MMX2.2	STAINLESS STEEL PVD



HIN-40015BU

BUTTERFLY HINGE WITH STEEL PIN

STOCK CODE	DESCRIPTION
HIN-40015BU	BUTTERFLY HINGE WITH STEEL PIN



HIN-20005BU

SS STAINLESS STEEL
SCREWS INCLUDED



HIN-20003BU

FINISHES
 BRASS PLATED
 SATIN NICKEL

SCREWS INCLUDED

FLUSH HINGE		
STOCK CODE	SIZE	FINISH
HIN-20005BU	100MM	STAINLESS STEEL

BALL BEARING FLUSH HINGE		
STOCK CODE	SIZE	FINISH
HIN-20002BU	100MM	BRASS PLATED
HIN-20003BU	100MM	CHROME PLATED
HIN-20004BU	100MM	SATIN NICKEL



HIN-40001BU

MILD STEEL

BULLET HINGE STEEL		
STOCK CODE	SIZE	FINISH
HIN-40001BU	M10X50	SELF COLOUR
HIN-40002BU	M12X70	SELF COLOUR
HIN-40003BU	M16X70	SELF COLOUR
HIN-40004BU	M16X100	SELF COLOUR
HIN-40005BU	M20X70	SELF COLOUR
HIN-40006BU	M20X100	SELF COLOUR
HIN-40007BU	M25X100	SELF COLOUR
HIN-40008BU	M30X120	SELF COLOUR

SECURITY

DOOR HARDWARE

HOOK LOCKS.....36
 CYLINDERS.....36
 FLIGHTS.....36
 GATE LOCKS.....37
 LOCK BOXES.....37



LOCK-00002BU

LOCK-00001BU



SCREWS INCLUDED

HOOK LOCKS

STOCK CODE	DESCRIPTION	FINISH
LOCK-00001BU	SLAM HOOK LOCK WITH ANTI LIFT PIN	CHROME PLATED
LOCK-00002BU	DEADBOLT HOOK LOCK WITH ANTI LIFT PIN	CHROME PLATED



TRX-FLIGHT

STEEL FLIGHT

STOCK CODE	SIZE	FINISH
TRX-FLIGHT	245X16X2MM	ZINC PLATED



CYL-00009BU



KEYED ALIKE

OVAL CYLINDER

STOCK CODE	DESCRIPTION	SIZE	FINISH
CYL-00009BU	KEY TO DIFFER	54MM	CHROME PLATED
CYL-00010BU	KEYED ALIKE	54MM	CHROME PLATED



COMPONENTS INCLUDED

LOCK-00009BU

DEAD LOCK

STOCK CODE	DESCRIPTION	SIZE
LOCK-00009BU	DEAD LOCK 40MM + 65MM BRASS PLATED CYLINDER	40MM



COMPONENTS INCLUDED

GATE LOCK

STOCK CODE	TYPE
LOCK-00035BU	N302



COMPONENTS INCLUDED

GATE LOCK

STOCK CODE	TYPE
LOCK-00036BU	ELZETTE

GATE LOCK BOX

STOCK CODE	TYPE	FINISH
LOCK-00050BU	CLOSED TYPE STEEL	ZINC PLATED



WOOD

WINDOW & DOOR HARDWARE

WOODEN WINDOW STAYS.....	40
CRANKED HINGES.....	41
SASH LIFT & SASH FASTENER.....	41
SOLID BRASS CASEMENT HANDLES.....	41
SOLID BRASS PULL & BOW HANDLES.....	42
SECURITY BOLTS.....	42
CABIN HOOKS.....	42
DOOR STOPPERS & DOOR CLOSERS.....	43
PIVOT HINGE.....	43
INDICATOR BOLTS.....	43
FLUSH BOLTS.....	43
PADBOLTS.....	44
GATE LATCH.....	44
BARREL BOLTS.....	45
HASP & STAPLES.....	45
TEE HINGES.....	45
DOOR LOCKS.....	46
DOOR HANDLES & LOCKSETS.....	48

SAMSON



HARD-30013BU

STEEL CASEMENT STAY

STOCK CODE	SIZE	FINISH
HARD-30013BU	300MM	YELLOW ZINC PLATED



HARD-30014BU



HARD-30032BU

X2

SUPPLIED AS PAIR

STEEL FANLIGHT STAY

STOCK CODE	SIZE	FINISH
HARD-30014BU	250M	YELLOW ZINC PLATED

STEEL EASY CLEAN STAY - LEFT & RIGHT

STOCK CODE	FINISH
HARD-30032BU	YELLOW ZINC PLATED



HARD-30021BU

FINISHES



SATIN NICKEL



SOLID BRASS

SOLID BRASS FANLIGHT STAY

STOCK CODE	SIZE	FINISH
HARD-30021BU	250MM	SOLID BRASS
HARD-30022BU	300MM	SOLID BRASS
HARD-30023BU	350MM	SOLID BRASS
HARD-30024BU	250MM	SATIN NICKEL
HARD-30025BU	300MM	SATIN NICKEL
HARD-30026BU	350MM	SATIN NICKEL



HARD-30015BU

FINISHES



SATIN NICKEL



SOLID BRASS



COMPONENTS INCLUDED

SOLID BRASS COMBINATION STAY

STOCK CODE	SIZE	FINISH
HARD-30015BU	250MM	SOLID BRASS
HARD-30016BU	300MM	SOLID BRASS
HARD-30017BU	350MM	SOLID BRASS
HARD-30018BU	250MM	SATIN NICKEL
HARD-30019BU	300MM	SATIN NICKEL
HARD-30020BU	350MM	SATIN NICKEL

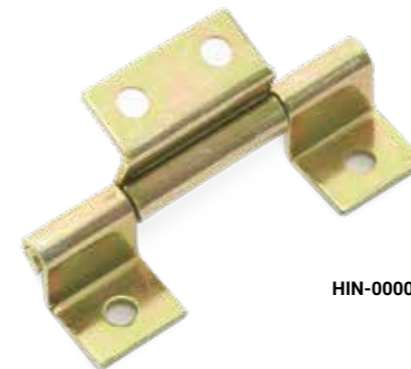

HIN-00005BU



HARD-00010BU



HARD-00025BU



SOLID BRASS



SCREWS INCLUDED

CRANKED HINGE

STOCK CODE	SIZE	FINISH
HIN-00005BU	64MM	YELLOW ZINC PLATED

SOLID BRASS SASH LIFT & SASH FASTENER

STOCK CODE	DESCRIPTION	FINISH
HARD-00010BU	SASH FASTENER	SOLID BRASS
HARD-00025BU	SASH LIFT	SOLID BRASS



HARD-40018BU



SOLID BRASS



SCREWS INCLUDED



HARD-40007BU



SOLID BRASS



SCREWS INCLUDED

SOLID BRASS CASEMENT HANDLE & WEDGE

STOCK CODE	FINISH
HARD-40018BU	SOLID BRASS

SOLID BRASS CASEMENT HANDLE & WEDGE

STOCK CODE	FINISH
HARD-40007BU	SOLID BRASS

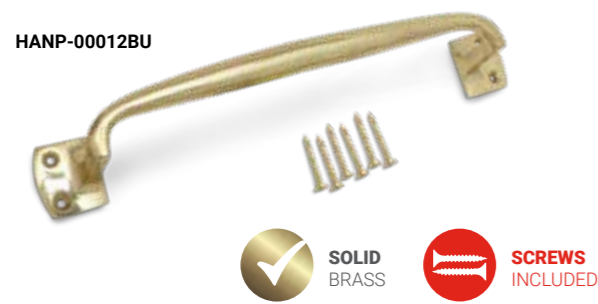

SOLID BRASS OFFSET PULL HANDLE		
STOCK CODE	SIZE	FINISH
HANP-00012BU	200MM	SOLID BRASS



SOLID BRASS BOW HANDLE		
STOCK CODE	SIZE	FINISH
HARD-40019BU	150MM	SOLID BRASS

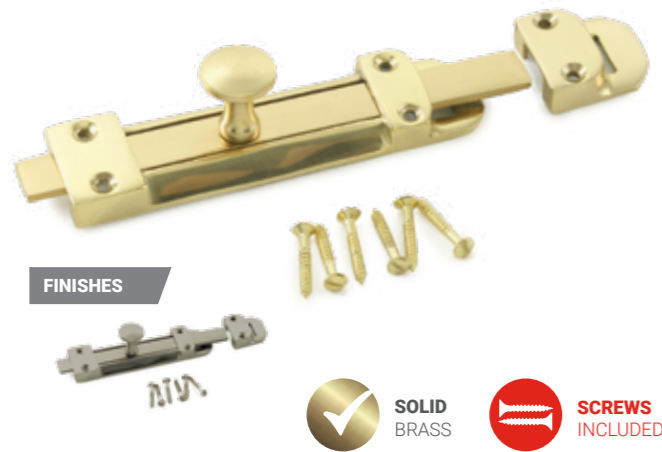

SOLID BRASS SECURITY BOLT		
STOCK CODE	SIZE	FINISH
BOLT-20007BU	100MM	SOLID BRASS
BOLT-20008BU	150MM	SOLID BRASS
BOLT-20010BU	100MM	SATIN NICKEL
BOLT-20011BU	150MM	SATIN NICKEL

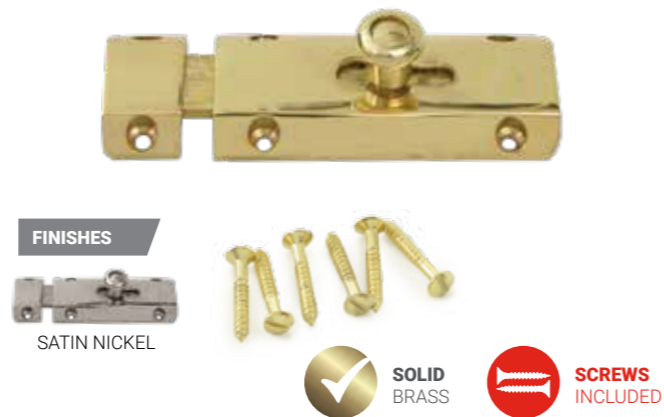

SOLID BRASS AUTO BOLT		
STOCK CODE	SIZE	FINISH
BOLT-30001BU	50MM	SOLID BRASS
BOLT-30002BU	75MM	SOLID BRASS
BOLT-30003BU	100MM	SOLID BRASS
BOLT-30004BU	50MM	SATIN NICKEL
BOLT-30005BU	75MM	SATIN NICKEL
BOLT-30006BU	100MM	SATIN NICKEL

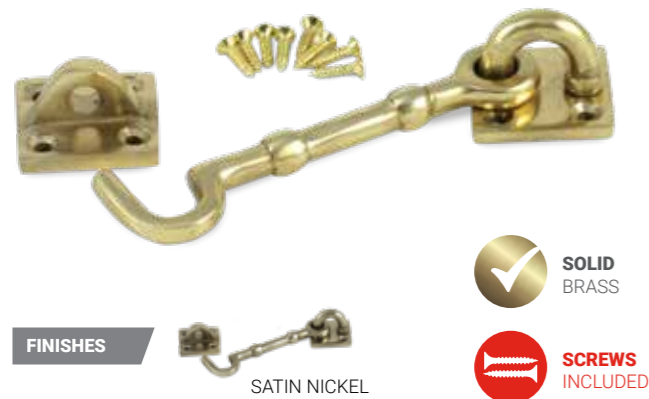

SOLID BRASS CABIN HOOK		
STOCK CODE	SIZE	FINISH
HARD-10016BU	75MM	SOLID BRASS
HARD-10017BU	100MM	SOLID BRASS
HARD-10018BU	150MM	SOLID BRASS
HARD-10021BU	75MM	SATIN NICKEL
HARD-10022BU	100MM	SATIN NICKEL
HARD-10023BU	150MM	SATIN NICKEL

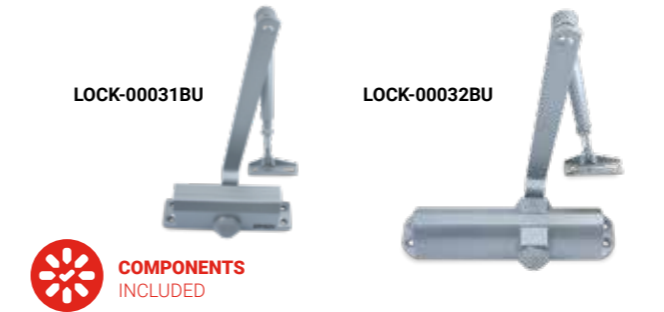

DOOR CLOSER	
STOCK CODE	DESCRIPTION
LOCK-00031BU	DOOR CLOSER (45KG DOOR)
LOCK-00032BU	DOOR CLOSER (60KG - 85KG DOOR)



DOOR STOP		
STOCK CODE	DESCRIPTION	FINISH
HARD-00005BU	DOOR STOP HALF MOON	SATIN NICKEL
HARD-00006BU	DOOR STOP MAGNETIC	SATIN NICKEL



SOLID BRASS PIVOT HINGE	
STOCK CODE	FINISH
HIN-00002BU	SOLID BRASS



INDICATOR BOLT	
STOCK CODE	FINISH
LOCK-00033BU	CHROME PLATED
LOCK-00034BU	SATIN NICKEL

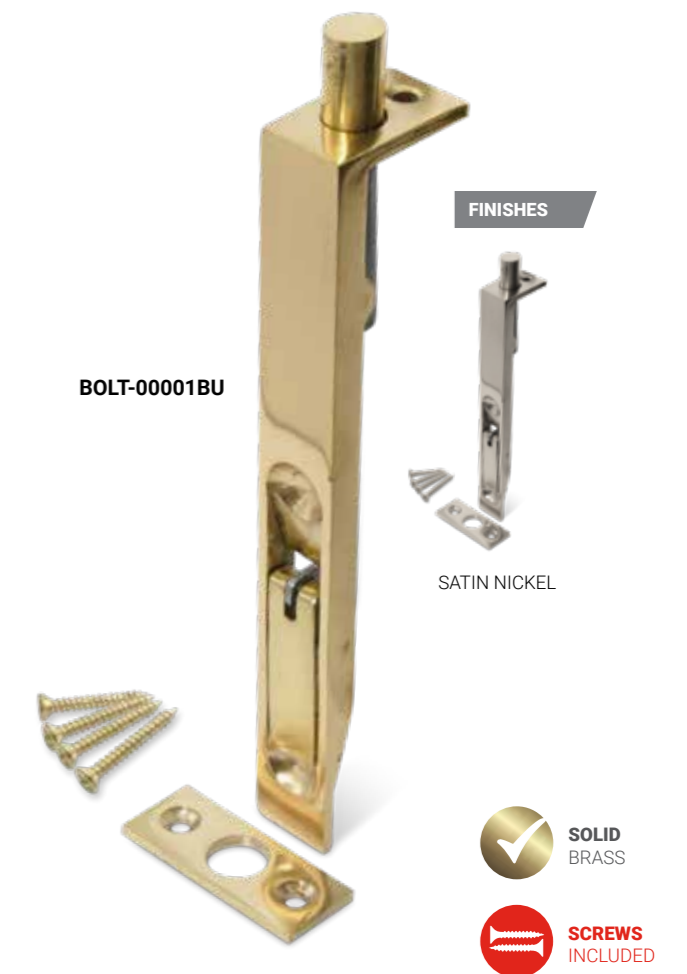

SOLID BRASS FLUSH BOLT		
STOCK CODE	SIZE	FINISH
BOLT-00001BU	150MM	BRASS PLATED
BOLT-00002BU	150MM	SATIN NICKEL



SCREWS INCLUDED

PADBOLT		
STOCK CODE	SIZE	FINISH
BOLT-40001BU	100MM	ZINC PLATED
BOLT-40002BU	150MM	ZINC PLATED
BOLT-40003BU	200MM	ZINC PLATED
BOLT-40004BU	250MM	ZINC PLATED



SCREWS INCLUDED

OVAL PADBOLT	
STOCK CODE	FINISH
BOLT-40006BU	ZINC PLATED



FINISHES
BLACK

BOLT-40007BU **SCREWS INCLUDED**

GATE LATCH	
STOCK CODE	FINISH
BOLT-40007BU	ZINC PLATED
BOLT-40009BU	BLACK



FINISHES
ZINC PLATED

SCREWS INCLUDED

BARREL BOLT STEEL		
STOCK CODE	SIZE	FINISH
BOLT-10025BU	100MM	BLACK
BOLT-10026BU	150MM	BLACK
BOLT-10027BU	200MM	BLACK
BOLT-10028BU	100MM	ZINC PLATED
BOLT-10029BU	150MM	ZINC PLATED
BOLT-10030BU	200MM	ZINC PLATED

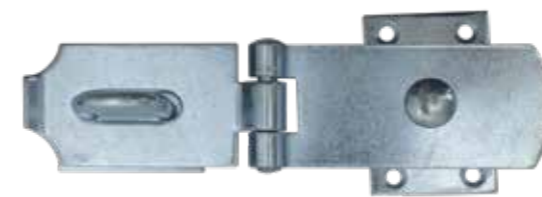

HARD-20014BU

SCREWS INCLUDED

HASP & STAPLE SWIVEL STEEL		
STOCK CODE	SIZE	FINISH
HARD-20014BU	200MM	ZINC PLATED



FINISHES

HARD-20006BU

BLACK

SCREWS INCLUDED

HASP & STAPLE STEEL		
STOCK CODE	SIZE	FINISH
HARD-20006BU	55MM	ZINC PLATED
HARD-20007BU	75MM	ZINC PLATED
HARD-20008BU	90MM	ZINC PLATED
HARD-20009BU	114MM	ZINC PLATED
HARD-20010BU	152MM	ZINC PLATED
HARD-20001BU	55MM	BLACK
HARD-20002BU	75MM	BLACK
HARD-20003BU	90MM	BLACK
HARD-20004BU	114MM	BLACK
HARD-20005BU	152MM	BLACK



HIN-30003BU

FINISHES

BLACK

SCREWS INCLUDED

X2 SUPPLIED AS PAIR

TEE HINGE STEEL		
STOCK CODE	SIZE	FINISH
HIN-30001BU	100MM	ZINC PLATED
HIN-30002BU	150MM	ZINC PLATED
HIN-30003BU	200MM	ZINC PLATED
HIN-30004BU	250MM	ZINC PLATED
HIN-30005BU	100MM	BLACK
HIN-30006BU	150MM	BLACK
HIN-30007BU	200MM	BLACK
HIN-30008BU	250MM	BLACK



LOCK-20002BU

FINISHES



BRASS PLATED



SABS KEYHOLE LOCKBODY

STOCK CODE	TYPE	FINISH
LOCK-20001BU	2 LEVER	BRASS PLATED
LOCK-20002BU	2 LEVER	CHROME PLATED
LOCK-30001BU	3 LEVER	BRASS PLATED
LOCK-30002BU	3 LEVER	CHROME PLATED
LOCK-40001BU	4 LEVER	BRASS PLATED
LOCK-40002BU	4 LEVER	CHROME PLATED

INFORMATION ABOUT MORTICE LOCK KEYS:

2 Lever - Y Series (Y1-Y18) 3 lever - CD Series (CD1-54)
4 lever - N Series (N101-148)



LOCK-30003BU

LOCK-30003BU



HEAVY DUTY SABS KEYHOLE LOCKBODY

STOCK CODE	TYPE	FINISH
LOCK-30003BU	3 LEVER	CHROME PLATED



LOCK-20004BU



PREMIUM SABS KEYHOLE LOCKBODY

STOCK CODE	DESCRIPTION	FINISH
LOCK-20004BU	2 LEVER SABS LOCKBODY	STAINLESS STEEL
LOCK-30004BU	3 LEVER SABS LOCKBODY	STAINLESS STEEL

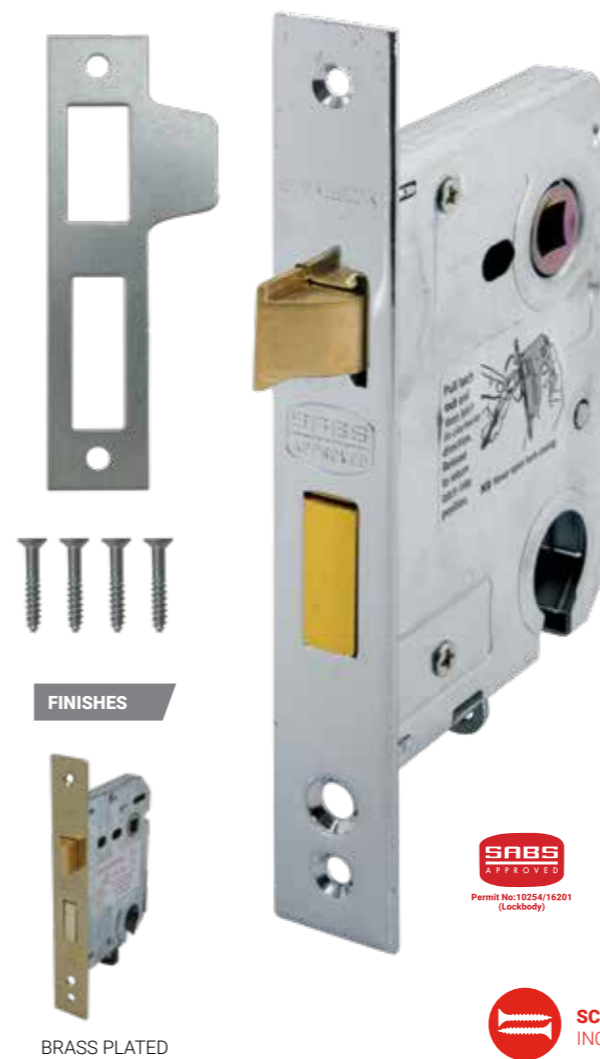

FINISHES



BRASS PLATED



SABS CYLINDER LOCKBODY

STOCK CODE	FINISH
LOCK-10003BU	CHROME PLATED
LOCK-10004BU	BRASS PLATED

EURO CYLINDER

STOCK CODE	TYPE	SIZE	FINISH
CYL-00005BU	KEY TO DIFFER	65MM	SATIN NICKEL
CYL-00006BU	KEY TO DIFFER	65MM	BRASS PLATED
CYL-00007BU	KEY TO DIFFER	65MM	CHROME PLATED
CYL-00008BU	KEYED ALIKE	65MM	SATIN NICKEL



PREMIUM SABS CYLINDER LOCKBODY

STOCK CODE	FINISH
LOCK-10005BU	STAINLESS STEEL



FINISHES



BRASS PLATED



CHROME PLATED





HANK-06001BU

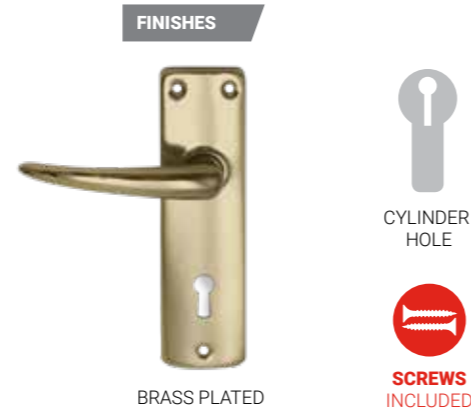

STANDARD 6 INCH HANDLE		
STOCK CODE	DESCRIPTION	FINISH
NORMAL KEY HOLE		
HANK-06001BU	HANDLE ONLY	CHROME PLATED
HANK-06002BU	HANDLE ONLY	BRASS PLATED
CYLINDER HOLE		
HANK-06001BU	CYLINDER HANDLE ONLY	CHROME PLATED



HANK-06003BU



ROMANO 6 INCH HANDLE AND LOCKSET		
STOCK CODE	DESCRIPTION	FINISH
HANK-06003BU	KEYHOLE HANDLE ONLY	CHROME PLATED
LSK-06037BX	2 LEVER SABS BOXED LOCKSET	CHROME PLATED
LSK-06040BX	3 LEVER SABS BOXED LOCKSET	CHROME PLATED



LSK-06036BX



STANDARD 6 INCH LOCKSET		
STOCK CODE	DESCRIPTION	FINISH
LSK-06036BX	2 LEVER SABS BOXED LOCKSET	CHROME PLATED
LSK-06039BX	3 LEVER SABS BOXED LOCKSET	CHROME PLATED
LSK-06043BX	4 LEVER SABS BOXED LOCKSET	CHROME PLATED



HANK-06004BU



MARCO 6 INCH HANDLE AND LOCKSET		
STOCK CODE	DESCRIPTION	FINISH
HANK-06004BU	KEYHOLE HANDLE ONLY	CHROME PLATED
LSK-06038BX	2 LEVER SABS BOXED LOCKSET	CHROME PLATED
LSK-06042BX	3 LEVER SABS BOXED LOCKSET	CHROME PLATED

GARAGE

LOCKS & HARDWARE

R02 GARAGE LOCK.....	52
GARAGE DOOR HANDLE & PLATE.....	52
R06 GARAGE DOOR LOCK	52
UBOLT CLAMP	52
NYLOFELT	52
BOTTOM CHANNEL & RUBBER	53
GARAGE DOOR WHEEL, CENTRE GUIDE & END CAP.....	53

SAMSON



R02 GARAGE LOCK		
STOCK CODE	DESCRIPTION	ACCESSORIES
GD-00001BU	R02 GARAGE LOCK	2 KEYS & SCREWS



GARAGE LOCK PLATE	
STOCK CODE	DESCRIPTION
GD-00003BU	DOOR PLATE BLANK WITH SCREWS

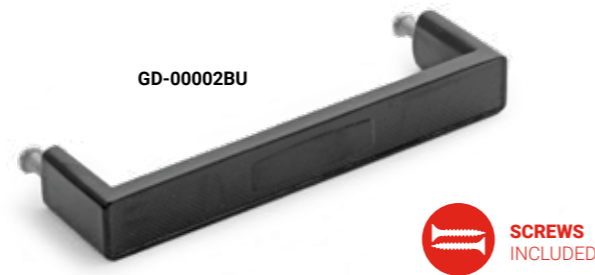

GARAGE LOCK HANDLE	
STOCK CODE	DESCRIPTION
GD-00002BU	DOOR HANDLE BLANK WITH SCREWS



R06 GARAGE LOCK	
STOCK CODE	DESCRIPTION
GD-00012BU	R06 GARAGE LOCK



CLAMP + UBOLT + FLANGE NUTS SET	
STOCK CODE	DESCRIPTION
GD-00005BU	CLAMP + UBOLT + FLANGE NUTS SET



GARAGE DOOR NYLOFELT		
STOCK CODE	DESCRIPTION	COLOUR
GD-00008BU	GARAGE DOOR NYLOFELT	BLACK

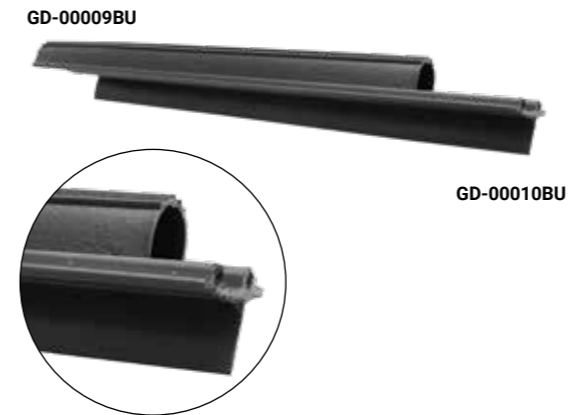

GARAGE DOOR BOTTOM CHANNEL AND RUBBER	
STOCK CODE	DESCRIPTION
GD-00009BU	GARAGE DOOR BOTTOM CHANNEL RUBBER 50M ROLL
GD-00010BU	GARAGE DOOR BOTTOM CHANNEL PVC 2550MM



NYLON GARAGE DOOR WHEEL	
STOCK CODE	COLOUR
GD-00006BU	BLACK



NYLON GARAGE DOOR WHEEL CENTRE GUIDE	
STOCK CODE	COLOUR
GD-00007BU	BLACK

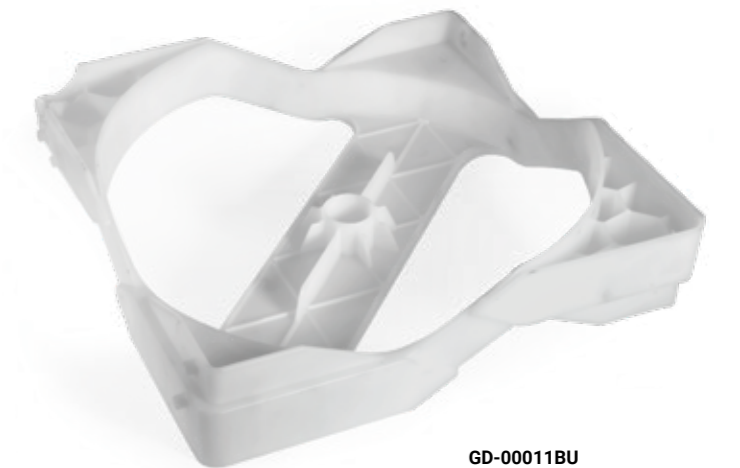

GARAGE DOOR NYLON END CAP	
STOCK CODE	DESCRIPTION
GD-00011BU	GARAGE DOOR END CAP NYLON



BOLTFIX HEAD OFFICE:

Tel: +27 31 713 9800

Fax Sales: +27 31 705 3956

Fax Admin: +27 31 705 3985

Address: Unit 11, Pine Industrial Park,
New Germany, 3620, KwaZulu Natal, South Africa